

Ultra Beam

Dynamic Antenna Systems

MANUAL "STANDARD"

YAGI 2-3-4-6 ELEMENTS 6-20

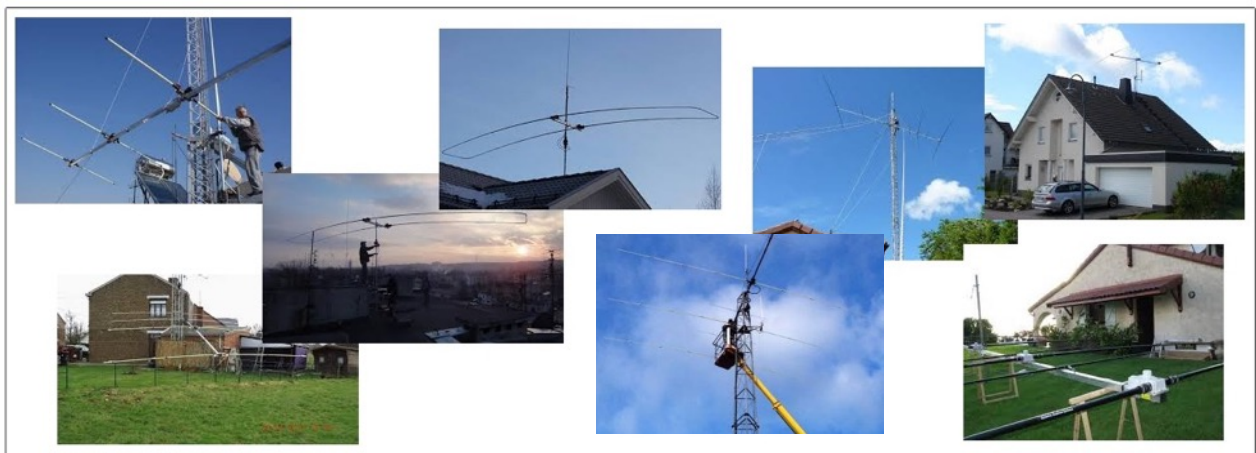

Rev. 1.10

INTRODCTION

UltraBeam produced its first antenna in 2008.

Since then there has been a progressive and continuous improvement in the design and manufacture of antennas, below are listed the main innovations:

- **2008** dual-driver circuitry to optimize spacing (necessary on some models)
- **2009** VRS System to improve reliability compared to spring-belt retraction systems
- **2010** Engine mounts with direct connection to the elements for a complete mechanical seal
- **2013** UB1040 the greatest dynamic antenna in the world with 10 motorized antenna elements
- **2014** UB80 with motorized rotary dipole coils, continuous coverage from 3.5 to 3.8 MHz.

Some innovations have become an international reference, valued and used today successfully even from other brands.

Since one of the most important aspects of an antenna is certainly the assembly (only processing performed by the client) it has been paid particular attention to the technical and mounting procedures in order to make it simple, intuitive and fast, also for people less accustomed to manual labor.

Last but not least the realization of electrical Plug and Play wiring made by UltraBeam, made extremely simple even the antenna electric side, sometimes not easy to understand and often source of post installation problems.

The main stages of assembly of an UltraBeam antenna are in fact common to many models. Simply reading this quick guide will allow you in a few minutes to acquire and memorize the necessary procedures so that you can make the assembly of your antenna so simple and clear but above all free from any doubt.

The only real difference between the different models is the length of the boom and the number of motor units installed on it, but as mentioned the procedures and assembly techniques remain unchanged. The major step to successfully install an UltraBream are only 5.

Once acquired assembly procedures. it will be sufficient to apply them to your model.

Step	Description
1	Boom assembly
2	Mounting brackets and motor unit on the boom
3	Preparation of telescopic elements
4	Elements Installation on motor unit
5	Electric Wiring

Contrary to what one might think, this guide will show the simplicity with which you can make a mechanical and electrical assembly of an UltraBeam

1) BOOM ASSEMBLY

UltraBeam uses for all models of antennas a square boom of section 60 x 60 x 3 mm. Only on the heavier models employs sections of 80 x 80 x 3 mm or 4 mm.

The boom may have 1 to 4 junctions depending on the model
Only 2 elements yagi have no junctions since are constructed as a single element.

Assemble each single junction as shown in the photo sequence, Fig. 1-2-3-4-5



Fig.1



Fig.2



Fig.3

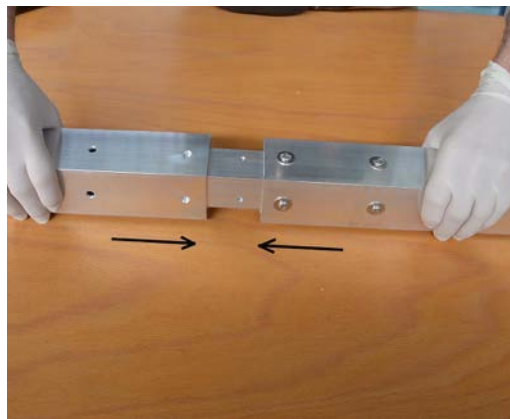

Fig.4



Fig.5

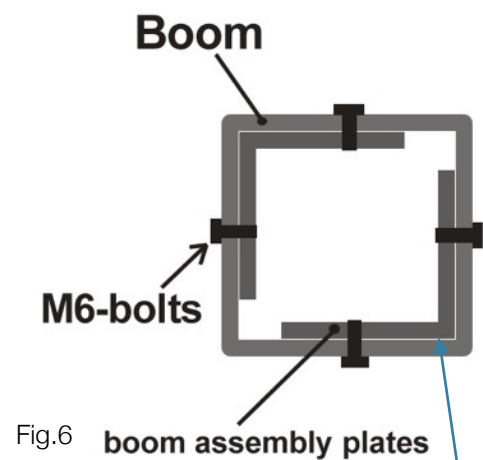

Fig.6

NOTE: before tightening the screws, make sure that both sides of the L are in contact with the boom

2) MOUNTING BRACKETS / MOTOR UNIT

The mounting of the engine mounts consists of 3 simple steps

Place the aluminum support on the boom and fix the same by means of the 4 M6 bolts and lower plates block (fig.1)

Before tightening the bolts check with a set square that the motor support is at 90 ° with respect to the boom, this will ensure a perfect parallelism between the elements.

Note: about the positioning of the motor unit on the boom you should refer to the antenna diagram (page 8) related to your model, however you need to know that the two external motor unit of the antenna (any model) will always place the boom ends with the cable facing towards the center (as shown in the photos) so no measure is to be verified.

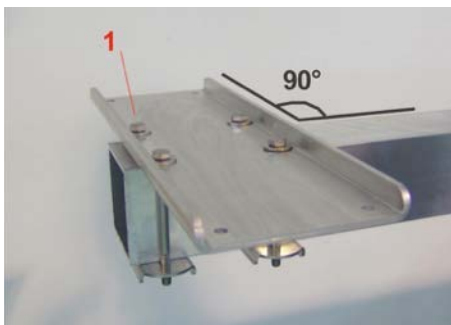

Fig.1

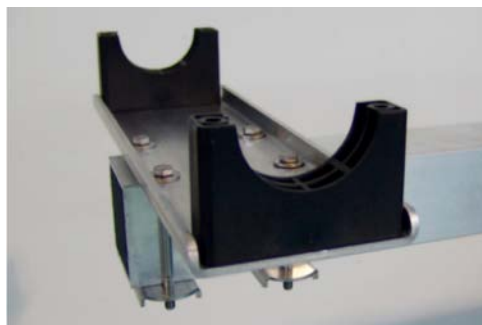

Fig.2

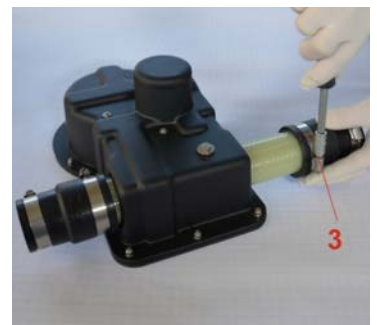

Fig.3

Place the lower ABS collars in correspondence of the outer holes of the support (fig.2)

Insert the rubber sleeves on the motor unit and tighten the internal clamp (fig. 3)

Place the motor unit on the support (Figure 4) and place the upper ABS collars (fig.5)

Insert the M6 x 110mm bolts and tighten.

Figure A shows the correct position of the motor unit with respect to the boom.



Fig.A

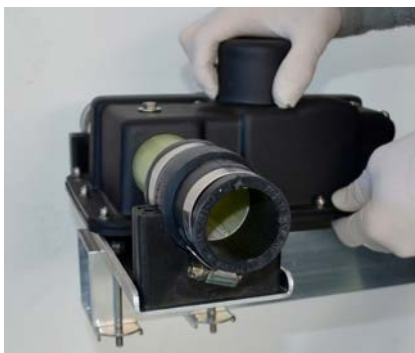

Fig.4



Fig.5



Fig.6

Nota: for tightening the screws, refer to the list below

BOLTS TIGHTENING

Passo	Description	Tightening Nm
M6	Screw bracket motor unit (1)	10
Endless screw	Screw rubber cap clamp (3)	6
M6	Bolt collars ABS (2)	8
M6	Boom junction screw	8

3) PREPARATION OF TELESCOPIC ELEMENT

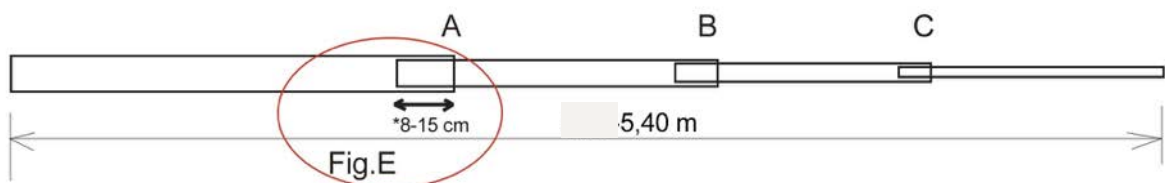

The glass fiber elements are formed by 4 telescopic sections, it will be sufficient to extend up to their maximum extension that every single conical junction can reach.

They have a size of about 5.4 m. the length can change depending on the model.

Open the element up to the maximum length, normally the internal section must remain inside the element that hosts it for a length between 8-15 cm. (fig.E) for this reason the maximum length reached by each individual element can be different from the other in the order of some cm, this is not a fault and it does not matter.

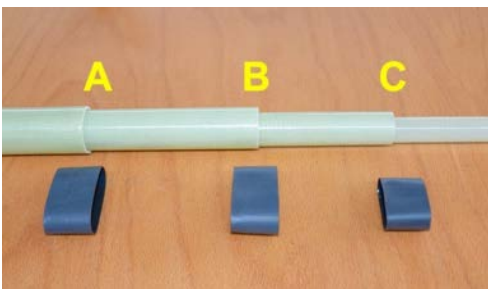

Fig.1

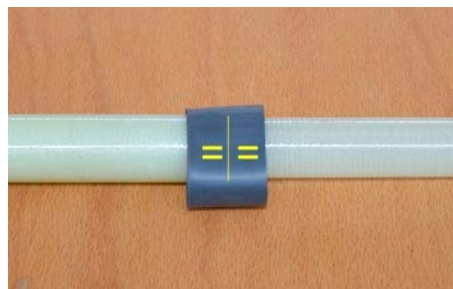

Fig.2



Fig.3

The three joints of the element are sealed by means of thermo-tightening with internal adhesive of appropriate diameter (Figure 1)

Place the sleeve exactly in the center of the junction (Figure 2)

Heat the sleeve with a heat gun until the same has not adhered completely to the element, the leakage of the adhesive to form a ring all around the edge will indicate that it has reached the correct temperature.

NOTE: excessive heat can damage the element

4) INSTALLATION OF ELEMENTS ON MOTOR UNIT

Loosen the outside of the rubber sleeve so that the element can slide up to where it can move, it will enter 10 cm. (Fig.1)

Tighten the rubber sleeve clamp (Figure 2) *

Repeat on opposite side.



Fig.1



Fig.2

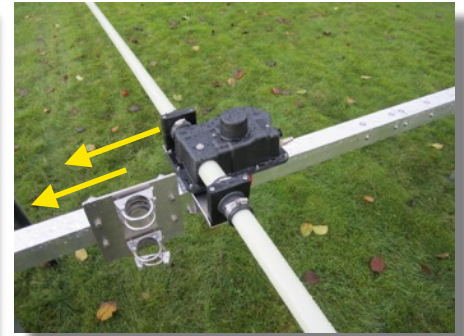

Fig.3

PIASTRA MAST/BOOM

All models are supplied with Ultrabeam Mast / aluminum boom plate.

Mast collars, boom brackets and bolts are made in stainless steel.

Each antenna model will have appropriate number and diameter of collars to match to the weight of the model.

On all antenna models with three motor units, the plates will always be fixed to the center boom, however, in cases where you need to increase the distance between the central element and the Mast, simply move the plate away from the motor (Fig.3) to achieve the necessary space for your set-up, this will be necessary only when you install the antenna on large sections wheeled tower.

On antenna models with 4 or more elements the position of the plate will be indicated directly on the boom.

In both cases you are free to move the specified location and if necessary can balance the antenna (only for repositioning more than 10 cm) by placing a small inner weight at the lighter boom end.



Diameter of mast collars supplied with antennas

U-Bolt Diameter mast mm.	50	60	65
2 elements 6-20 / 6-40 / UB20	✓	/	/
3 elements 6-20 / UB50 / 4 El. DX	✓	optional	/
UB640-VL1.3 / VL2.3	✓	optional	/
4 elements 6-20	✓	optional	optional
3 elements 6-40 / 4 elements 6-40	optional	✓	optional
UB640-VL3.4 / UB40	optional	✓	optional

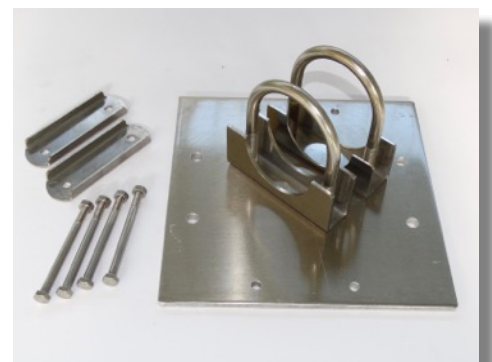

BOOM TIE-ROPE

Most UltraBeam models does not need any tie rope, the square section boom on models with boom within 6 meters offer a very high stiffness and remain perfectly straight. Only models with boom lengths over 9 meters provide a tie-beam on the boom.

Models that provide the tension rope:

- UB640-VL3.4
- 4 ELEMENTI 6-20
- 4 ELEMENTI 6-40
- 6 ELEMENTI 6-20 DX



Fig.1

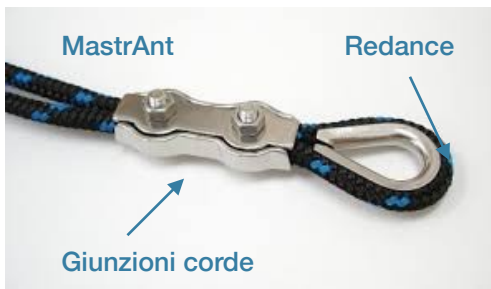

Fig.2

The models shown are provided with a complete kit of excellent MastrAnt ropes of suitable section for the model.

All strings and joints thimbles are made of stainless steel.

On the two outer sections of the boom holes are drilled on which you simply insert and tighten the through bolt with eyelet head (fig.1) which will be inserted in the appropriately closed rope with double stainless junction (fig.2)

The ropes are supplied with proper length and allow you to make your personal set-up "A"

The vertical measurement "A" between boom and mast to which the strings will be attached should be between 1.5 -2.5 m. The heavier the antenna, the greater will be the distance from the antenna boom. For example on a 4 6-40 elements it should not be lower than 2 m.

In any case, regardless of the model you should never fix in the cable at distances "A" less than one meter. This would bring an excessive load on the ropes and poor alignment of the boom.

With the ropes kit you get a junction for mast collars to tie the ropes, of course you can use your own fixture if already present on your mast.

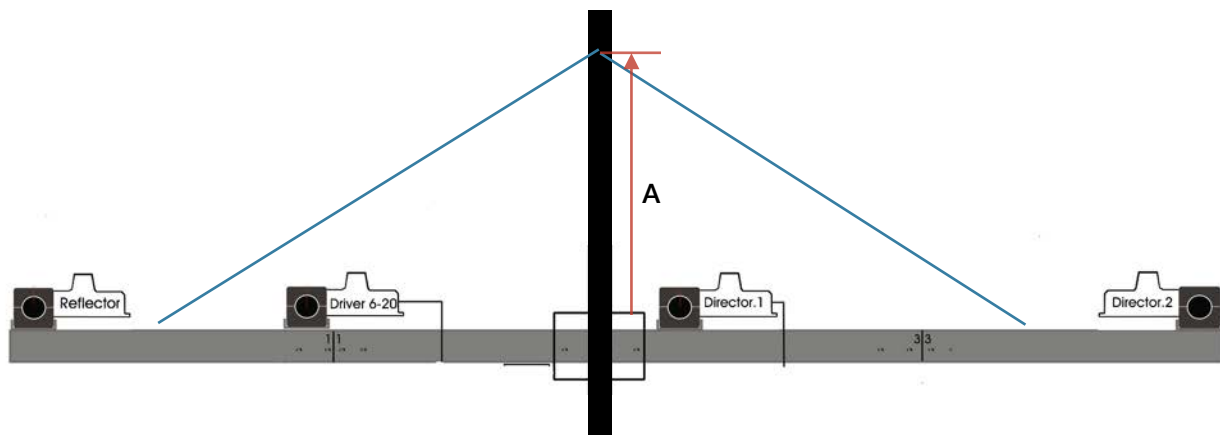

5) ELECTRICAL WIRING

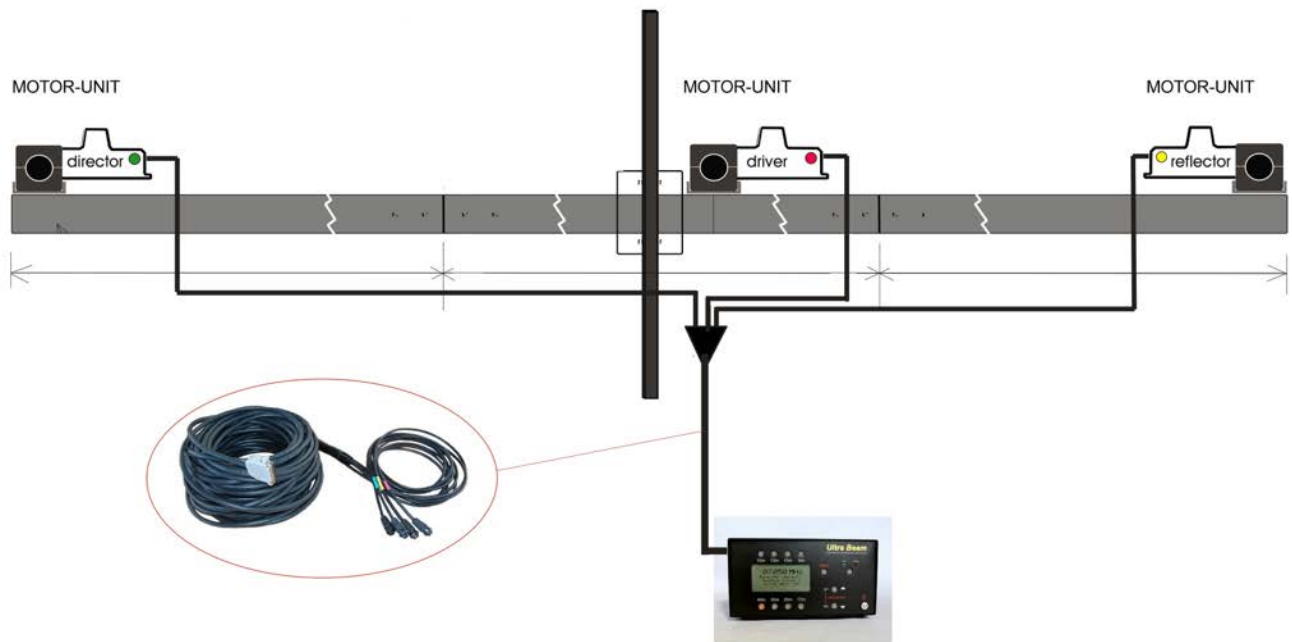

The electrical wiring built and assembled by UltraBeam are the best solution for electric connection between the antenna and the electronic controller.

In these cases, the antenna motor units will be equipped with multi-pole female connectors.

Simply plug in the connectors to the engine unit and the DB25 to the controller, no chance to operating errors and to guarantee high reliability over time.

Furthermore, the assembled wiring does not contain the junction points along the route, which is often cause of bad electrical contacts especially for external systems, each wire goes from the controller to the motor.

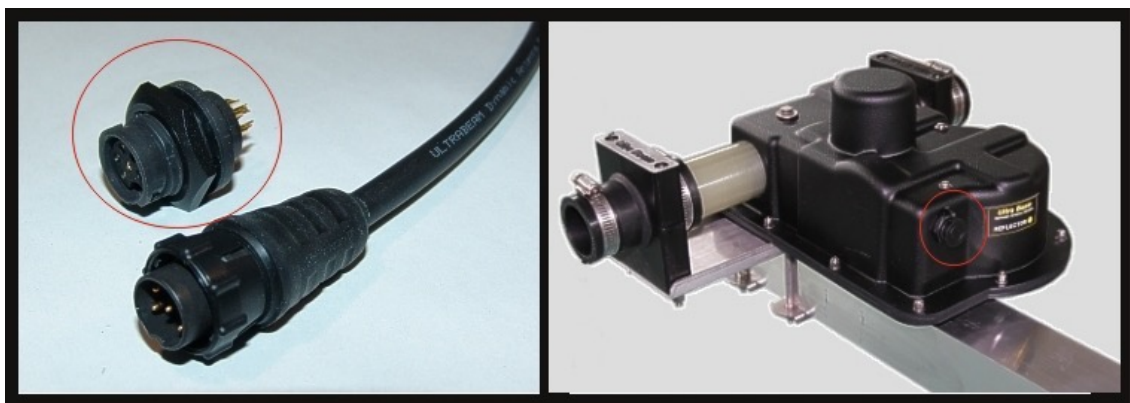

The multi-wire cables used in the construction of the wiring are build specifically on UltraBeam specifications

The water resistance and protection against UV rays make the wiring particularly suitable for outdoor use and offer increased reliability compared to common commercial cables

The connectors used are IP68 with gold contacts by Switchcraft Inc.

ANTENNA MODEL SCHEME

SCHEMA -Yagi 2 elements 6-20

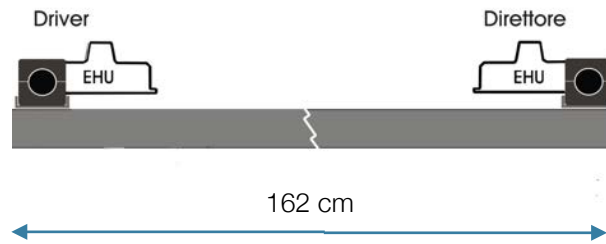

Boom 1 x 162 cm
Sezione 60 x 60

SCHEMA - Yagi 3 elements 6-20

POSIZIONAMENTO MOTOR UNIT SU BOOM

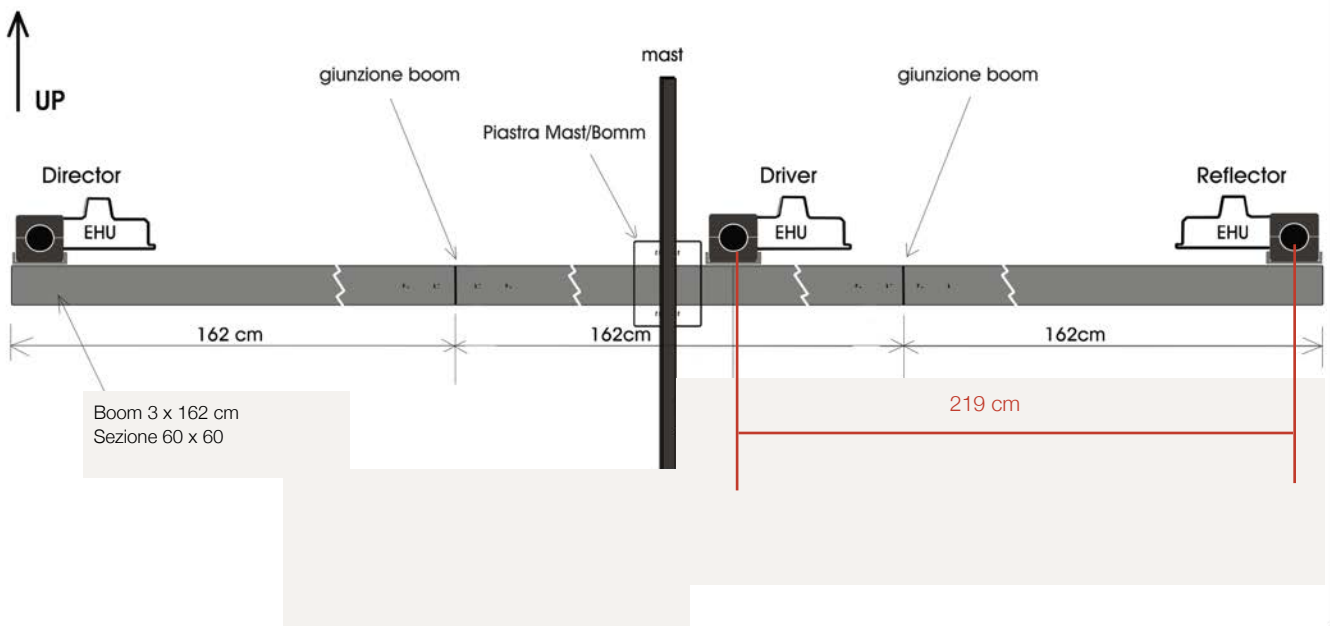

4 ELEMENTS YAGI 6-20

- POSIZIONAMENTO MOTOR UNIT SU BOOM
- POSITIONING MOTOR UNIT ON BOOM

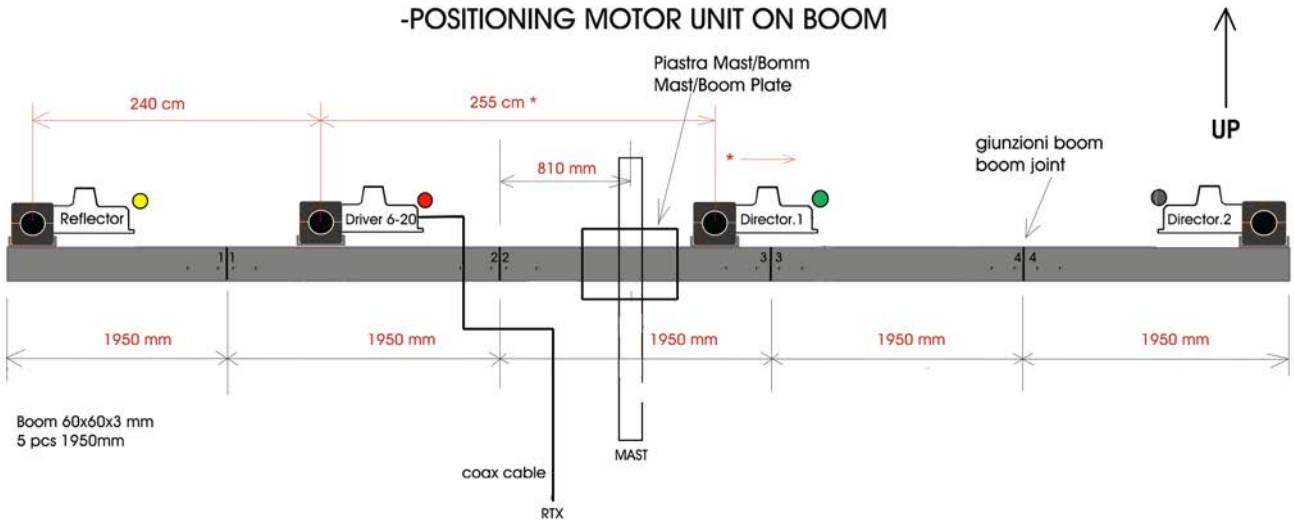

4 ELEMENTS 6-20 DX

- POSIZIONAMENTO MOTOR UNIT SU BOOM
- POSITIONING MOTOR UNIT ON BOOM

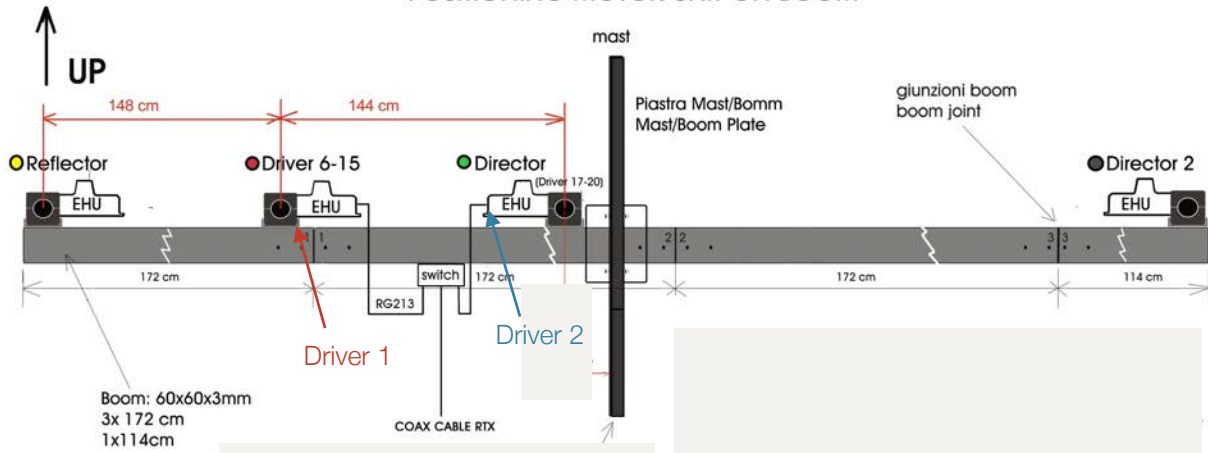

YAGI 6 ELEMENTS 6-20 DX

-POSIZIONAMENTO MOTOR UNIT SU BOOM
-POSITIONING MOTOR UNIT ON BOOM

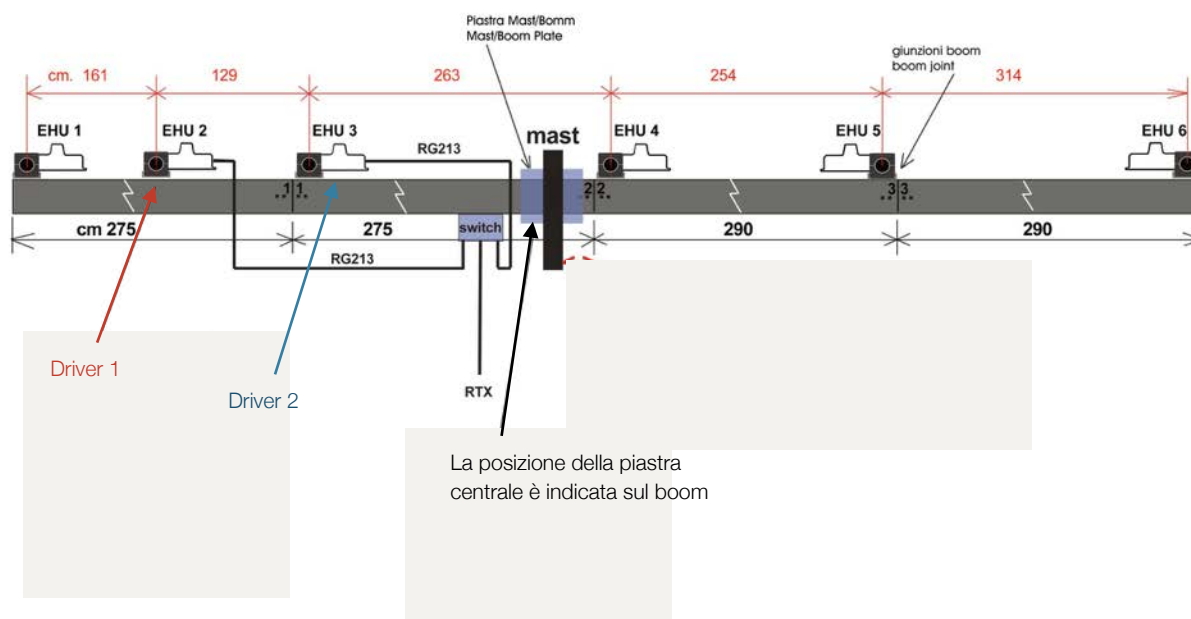

CONCLUSIONS

A manual of a few pages can seem deceptively simplistic ... actually the use of only 8 pages to describe the assembly of 2-3-4 elements yagi 6-20 are proof of quality design and how extremely simple as well as intuitive is the assembly of a UltraBeam antenna.

Texts, images and graphics have been prepared to offer the user maximum ease of self learning and memorize.

In contrast with manual of many pages that can only confuse an OM that having never installed an antenna of this type could acquire too much informations and new procedures to him.

Reading new manuals waiting to receive your new antenna will allow you to perform a quick installation, safe and free of errors.

Therefore a careful reading is recommended in order to acquire the assembly methods which, as you may have seen, are really very intuitive.

Do work when your mind already knows what to do and provides a better end result in fewer time than a set-up in which you should consult the manual step by step for each individual operation.

Finally, and not least ...

Perform the antenna set-up exclusively as described in the manuals.

Avoid any variable and / or customization.

If you plan to do something that is not described in the manual, it means you should not do it !!!