

# RF Direct Sampling Takes You to the Next Level

Outstanding HF Experience Right Here

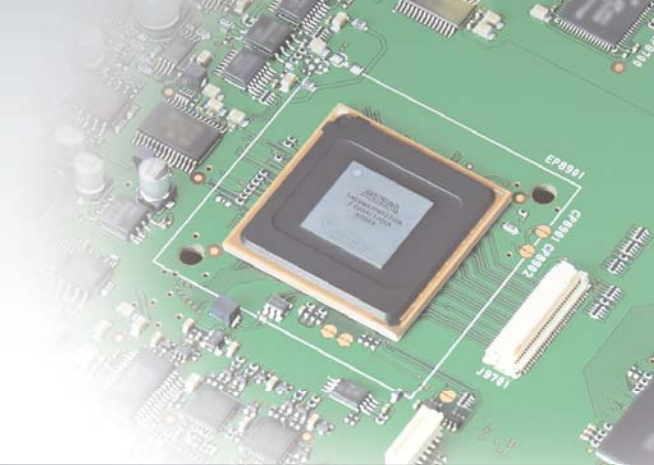

# RF Direct Sampling Takes You to the Next Level with Advanced RMDR and True Dual Receive



Whether it is poor band conditions, or battling to pick out a call in a large pile-up, faint signals have always been a challenge for DXers and Contesters around the world.

The difference between putting the QSO in the log or having to try another time is the capability of your receiver. One key factor is the RMDR capabilities, the ability to pick out a faint signal in the presence of stronger, adjacent signals.

The IC-7610 introduces dual RF direct sampling receivers, achieving 110dB RMDR, rivaling that of top-of-the-line transceivers.

HF/50MHz TRANSCEIVER

# IC-7610



Actual size

# Superior Receiver Performance and High-Purity Transmitter



## Innovative RF Direct Sampling System

Introduced with the IC-7300, Icom's RF Direct Sampling System has made SDR performance affordable. Direct Sampling means incoming RF signals are digitized by the Analog-to-Digital Converter and immediately processed by the FPGA (Field-Programmable Gate Array). This process greatly reduces distortion that naturally occurs in the various mixer stages found in traditional super-hetrodyne receivers.



## Astonishing 110 dB\* RMDR

The RF Direct Sampling System in the IC-7610 is capable of 110 dB RMDR. This performance gives you the ability to pull weak signals out of the noise of strong adjacent signals. There is a difference you can actually hear as the desired signal comes out of the pileup!

\* Representative value at 2 kHz frequency separation (Received frequency: 14.2 MHz, Mode: CW, IF BW: 500 Hz)

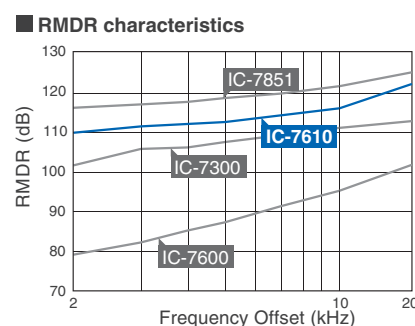

## Customized VCXO Is Used for the Master Clock

Reducing phase noise in a receiver is always a challenge as it is a natural characteristic of a receiver. The master clock of the IC-7610 utilizes a low phase noise VCXO (Voltage Controlled Crystal Oscillator), combined with Icom's years of technical expertise to design a common power supply for the VCXO and FPGA, yielding an ultra-low phase noise. Also, a 10 MHz reference signal can be input to the IC-7610 for higher precision.



## Independent Dual Receiver

Whether listening to both sides of a rare DX station running split, or looking for a multiplier on a different band or mode, the dual receivers in the IC-7610 have you covered. Two separate DIGI-SEL preselectors, two separate Band Pass Filter networks, feed two separate A/D converters into the FPGA.

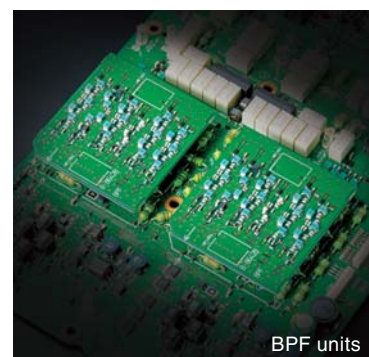
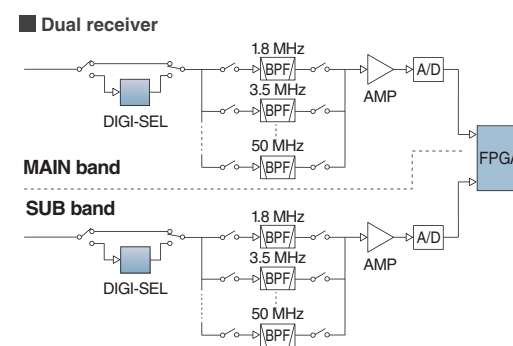

## DIGI-SEL for Main and Sub Bands

The DIGI-SEL preselectors are RF filters with sharp, narrow passband characteristics preventing Analog-to-Digital Converter overflow from large out-of-band signals when sampling the RF signals. Additionally the third and higher order IMD components are reduced. This is ideal when strong signals are received in a contest pile-up or from broadcast stations on adjacent frequencies or bands.

■ BPF and preselector passband characteristics receiving on 7.22 MHz

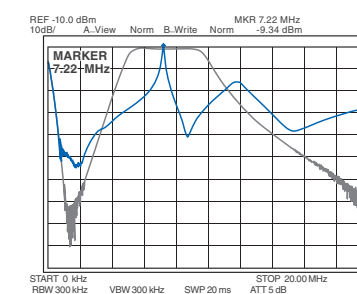

■ Passband characteristics between the antenna and the preselector (at the preselector output)

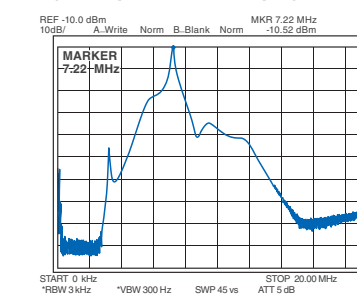

## High Quality Speaker Sound

To finish out the receiver, is an internal speaker cabinet. The cabinet is tuned to reproduce clear, natural sounding audio, and is insulated from the radio chassis to prevent noise from vibration and panel resonance.



## Digital-Up-Conversion (DUC) for Clean TX

Breaking with the tradition of mixing a carrier signal with a local oscillator, a Digital-Up-Conversion (DUC) method is used to generate the required signal from the Digital-to-Analog Converter. The chart to the right shows the difference made by this new design.

■ Transmit phase noise characteristics

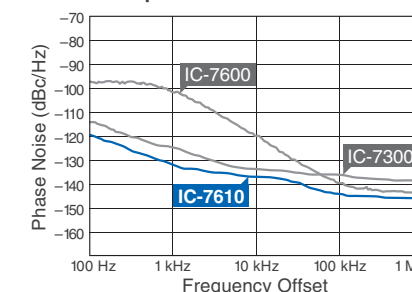

## Built-in Automatic Antenna Tuner

The built-in automatic antenna tuner memorizes its settings based on your transmit frequency, so that it can recall the tuning setting when you switch operating bands. The emergency tuner function\* enables you to operate for short periods of time with an antenna with a high SWR.

\* Output power not guaranteed and power may be reduced.



# Intuitive Operation and Versatile Functions

## 7-inch Color Display with Touch Screen Function

The large 7-inch color display shows various operating and setting information at a glance in high resolution (800 × 480 pixels.) The display clearly shows various features, for example the dual spectrum scope aligned vertically or horizontally, simulated analog meters and RTTY, PSK31/63 mode decoded messages.

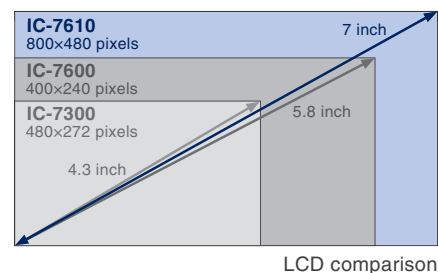

LCD comparison

## Dual Receivers, Dual Spectrum Scopes

The IC-7610 provides dual reception, on different bands, as does the high-speed, high-resolution spectrum scopes. Whether watching for a band opening, working a rare DX station operating split, or searching for a multiplier, the ability to watch each receiver separately allows the operator to concentrate on pulling in a weak signal. The scopes provide class-leading performance in resolution, sweep speed and a 100 dB dynamic range. To navigate around the band easier, connect a PC mouse to the USB port for point and click tuning of the receivers.

	IC-7610	IC-7300	IC-7600
Span width	5 kHz – 1000 kHz		5 kHz - 500 kHz
Resolution	1 pixel minimum*		20 pixels minimum*
Sweep speed	Max. 30 frames/second (approximate)		Max. 4 frames/second (approximate)
Waveform display area	100 dB	80 dB	70 dB
Dual Receiver	Dual		Single
Mouse Operation	Yes	N/A	Yes

\* Number of pixels shown at the 60 dB level, when receiving a signal.

## Audio Scope Flexibility

The Audio Scope screen shows both a FFT scope with waterfall along with an oscilloscope for both transmit and receive audio. This makes it easy to monitor AF characteristics such as microphone compressor level, filter width, notch filter, and in CW, you can monitor received CW keying wave forms.



Audio scope example

## Touch Screen and Multi-Dial Knob for Smooth Operation

The combination of the touch screen and the multi-dial knob offers quick and smooth operation. When you push the multi-dial knob, menu items are shown on the right side of the display. You can select an item by touching the screen and can adjust the levels by turning the multi-dial knob.



## Remote Encoder for Second VFO Knob

The optional RC-28 remote encoder enables you to add an external Sub dial for controlling the Sub band. Main band and Sub band can be switched with the F1 and F2 buttons and can be controlled with the RC-28. The LED above the F1 and F2 buttons turns ON to show the active band.



## DVI-D Connector for an External Display Connection

The IC-7610 has a DVI-D connector for an external display. Operating frequency, setting information and spectrum scope can be observed on a large external display.

## SD Card Slot and USB Port for Saving Data

When used with an SD card or USB flash drive, various contents including firmware updates, memory channels, captured screen images, and other personal settings, can be saved and loaded. TX/RX audio, voice memories, RTTY/CW memories and RTTY decode logs can be saved and used on the SD card.

## I/Q Signal Output

The IC-7610 enables you to output I/Q signals from the USB connector. They can be used to analyze a spectrum range or to decode signals by a decoder software on a PC.

\*This function will be provided in a future firmware update.

## Simplified Remote Control for RS-BA1

Whether from a remote part of your home QTH, or on a remote location somewhere around the world, the RS-BA1 software enables you to operate your IC-7610. Not only can you control the radio settings and have both RX/TX audio paths, you are able to display a single band spectrum scope with the waterfall. With the addition of an Ethernet connector, a base station computer is not required.

## Other Outstanding Features

- RX antenna**
  - BNC type RX IN/OUT connectors for a receiver antenna or external BPF/preamp connection
- CW mode**
  - FPGA-controlled CW keying waveform shaping
  - Multi-function electronic keyer
  - CW pitch control from 300 Hz to 900 Hz
  - Auto repeat function
  - Contest serial number counter
  - Normal or short Morse number style
  - Double key jack system
  - Full break-in and semi break-in
  - CW auto tuning
  - APF (Audio Peak Filter) function adjustable filter shape, width and AF level
- Receiver**
  - 30 kHz to 60 MHz receiver (Some frequencies are not guaranteed.)
  - Two types of preamplifiers
    - Preamp 1: Improves intermodulation characteristics
    - Preamp 2: High gain preamplifier
  - 3 dB – 45 dB variable attenuator
  - IP+ function improves 3rd order intercept point performance
  - 101 memory channels
  - RTTY encoder and decoder
  - Twin peak audio filter for the RTTY mode
  - Adjustable AGC time constant from 0.1 to 6 seconds
  - Digital twin PBT eliminates interference from adjacent signals
  - Main/Sub band tracking function for diversity reception
- Transmitter**
  - TX monitor function
  - All mode power control
  - VOX (Voice Operated transmission) capability
  - BNC type transverter connector
  - Microphone equalizer and adjustable transmit bandwidth
  - 50 CTCSS tones
- Operation**
  - Memo pad stores up to 10 operating frequencies and modes
  - Quick split function
  - Quick Dualwatch function
  - RF gain and squelch control with a knob
  - RIT and ΔTX variable up to 9.999 kHz
  - UTC/local clock and timer function
  - 1 Hz pitch tuning and display
  - Dial lock function
  - Adjustable main dial brake
  - External speaker jacks for Main and Sub receivers
  - Screen saver function
  - Multi-function meter (S-meter, Power, ALC, COMP, SWR, ID, VD and TEMP)
  - Auto tuning step function

## Rear Panel View

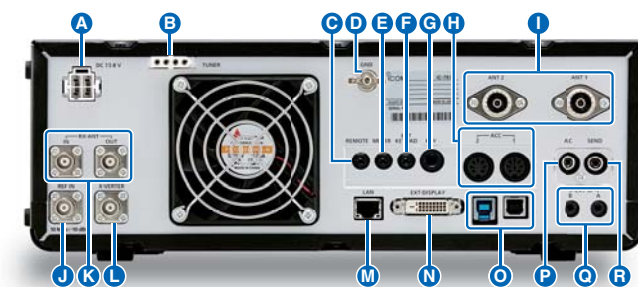

- A 13.8V DC Power Socket
- B Tuner Control Socket
- C CI-V Remote Control Jack
- D Ground Terminal
- E S-meter Output Jack
- F External Keypad Jack
- G Key Jack
- H Accessory Sockets
- I Antenna Connectors
- J 10 MHz Reference Frequency Input
- K Receive Antenna Connectors
- L Transverter Connector
- M LAN (Ethernet) Connector
- N External Display Connector
- O USB Connectors
- P ALC Input Jack
- Q External Speaker Jacks
- R SEND Control Jack

## SPECIFICATIONS

GENERAL		
Frequency coverage	Receiver* <sup>1</sup>	0.030–60.00 MHz* <sup>2</sup>
	Transmitter* <sup>1</sup>	1.800–1.999, 3.500–3.999, 5.255–5.405* <sup>3</sup> 7.000–7.300, 10.100–10.150, 14.000–14.350, 18.068–18.168, 21.000–21.450, 24.890–24.990, 28.000–29.700, 50.000–54.000 MHz
* <sup>1</sup> USA version. Varies according to version. * <sup>2</sup> Guaranteed range: 0.500–29.999, 50.000–54.000 MHz. * <sup>3</sup> Some frequency bands are not guaranteed.		
Mode	USB, LSB, CW, RTTY, PSK31/63, AM, FM	
Number of channels	101 (99 regular, 2 scan edges)	
Antenna connectors	SO-239 × 2 (50 Ω unbalanced (Tuner off)) BNC × 1 (RX antenna In/Out)	
Power supply requirement	13.8 V DC ±15%	
Power consumption	Tx	23 A (at 100 W output power)
	Rx	3.0 A (Standby), 3.5 A (Maximum audio)
Operating temperature range	0 °C to +50 °C; 32 °F to 122 °F	
Frequency stability	Less than ±0.5 ppm (0 °C to +50 °C; 32 °F to 122 °F)	
Frequency resolution	1 Hz (fine)	
Dimensions (W × H × D) (projections not included)	340 × 118 × 277 mm; 13.4 × 4.6 × 10.9 in	
Weight (approximately)	8.5 kg; 18.7 lb	
TRANSMITTER		
Output power (HF/50 MHz)	SSB/CW/FM/RTTY/PSK: 1–100 W, AM: 1–25 W	
Modulation system	SSB	Digital P.S.N. modulation
	AM	Digital Low power modulation
	FM	Digital Reactance modulation
Spurious emissions	HF bands	Less than –50 dB
	50 MHz band	Less than –63 dB
Carrier suppression	More than 50 dB	
Unwanted sideband	More than 50 dB	
Microphone impedance	600 Ω	

## OPTIONS

Some options may not be available in some countries. Please ask your dealer for details.

<b>EXTERNAL SPEAKERS</b>  <p><b>SP-23</b> 4 audio filters, headphone jack</p> <p><b>SP-33</b> Wooden box speaker</p> <p><b>SP-34</b> 4 audio filters; headphone jack</p>	<b>DESKTOP MICROPHONES</b>  <p><b>SM-30</b> Compact, lightweight electret microphone.</p> <p><b>SM-50</b> Dynamic microphone with [UP/DOWN] switches and a low cut function.</p>	<b>HM-219</b> HAND MICROPHONE  <p>Same as supplied.</p>	<b>AH-4</b> HF+50 MHz AUTOMATIC ANTENNA TUNER  <p>Covers 3.5–54 MHz with a 7 m (23 ft) or longer wire antenna.</p>	<b>AH-2b</b> ANTENNA ELEMENT  <p>Covers 7–54 MHz. For use with AH-4.</p>	<b>AH-740</b> AUTOMATIC TUNING ANTENNA  <p>Covers 2.5–30 MHz (amateur band). OPC-2321 is required.</p>
<b>RC-28</b> REMOTE ENCODER 	<b>RS-BA1</b> IP REMOTE CONTROL SOFTWARE 	<b>IC-PW1/PW1EURO</b> HF+50 MHz 1 kW HF LINEAR AMPLIFIER 	<b>PS-126</b> DC POWER SUPPLY  <p>13.8 V DC, 25 A max. output.</p>	<b>AH-710</b> FOLDED DIPOLE ANTENNA  <p>Covers 1.9–30 MHz bands.</p>	<b>AH-5NV</b> NVIS KIT  <p>Fiberglass mobile mounting antenna element for use with AH-740. Covers 2.2–30 MHz (amateur band) with AH-740.</p>

- **OPC-420:** CONTROL CABLE for use with AH-4 (10 m; 32.8 ft)
- **OPC-2321:** CONTROL CABLE for use with AH-740 (6 m; 19.7 ft)
- **MB-121:** CARRYING HANDLE

Icom, Icom Inc. and the Icom logo are registered trademarks of Icom Incorporated (Japan) in Japan, the United States, the United Kingdom, Germany, France, Spain, Russia, Australia, New Zealand and/or other countries. This product includes "zlib" and "libpng" open source software, and is licensed according to the open source software license.

Icom Inc. 1-1-32, Kamiminami, Hirano-Ku, Osaka 547-0003, Japan Phone: +81 (06) 6793 5302 Fax: +81 (06) 6793 0013

[www.icom.co.jp/world](http://www.icom.co.jp/world)

Count on us!

## Icom America Inc.

12421 Willows Road NE,  
Kirkland, WA 98034, U.S.A.  
Phone: +1 (425) 454-8155  
Fax: +1 (425) 454-1509  
E-mail: [sales@icomamerica.com](mailto:sales@icomamerica.com)  
URL: <http://www.icomamerica.com>

## Icom Canada

Glenwood Centre #150-6165  
Highway 17A, Delta, B.C.,  
V4K 5B8, Canada  
Phone: +1 (604) 952-4266  
Fax: +1 (604) 952-0090  
E-mail: [info@icomcanada.com](mailto:info@icomcanada.com)  
URL: <http://www.icomcanada.com>

## Icom Brazil

Rua Itororó, 444 Padre Eustáquio  
Belo Horizonte MG,  
CEP: 30720-450, Brazil  
Phone: +55 (31) 3582 8847  
Fax: +55 (31) 3582 8987  
E-mail: [sales@icombrasil.com](mailto:sales@icombrasil.com)

## Icom (Europe) GmbH

Communication Equipment  
Auf der Krautweide 24  
65812 Bad Soden am Taunus, Germany  
Phone: +49 (6196) 76685-0  
Fax: +49 (6196) 76685-50  
E-mail: [info@icomeurope.com](mailto:info@icomeurope.com)  
URL: <http://www.icomeurope.com>

## Icom Spain S.L.

Ctra. Rubi, No. 88 "Edificio Can Castanyer"  
Bajos A 08174, Sant Cugat del Valles,  
Barcelona, Spain  
Phone: +34 (93) 590 26 70  
Fax: +34 (93) 589 04 46  
E-mail: [icom@icomspain.com](mailto:icom@icomspain.com)  
URL: <http://www.icomspain.com>

## Icom (UK) Ltd.

Blacksole House, Altira Park,  
Herne Bay, Kent, CT6 6GZ, U.K.  
Phone: +44 (0) 1227 741741  
Fax: +44 (0) 1227 741742  
E-mail: [info@icomuk.com](mailto:info@icomuk.com)  
URL: <http://www.icomuk.com>

## Icom France s.a.s.

Zac de la Plaine,  
1 Rue Brindejonc des Moulinais, BP 45804,  
31505 Toulouse Cedex 5, France  
Phone: +33 (5) 61 36 03 03  
Fax: +33 (5) 61 36 03 00  
E-mail: [icom@icom-france.com](mailto:icom@icom-france.com)  
URL: <http://www.icom-france.com>

## Icom (Australia) Pty. Ltd.

Unit 1 / 103 Garden Road,  
Clayton, VIC 3168 Australia  
Phone: +61 (03) 9549 7500  
Fax: +61 (03) 9549 7505  
E-mail: [sales@icom.net.au](mailto:sales@icom.net.au)  
URL: <http://www.icom.net.au>

## Shanghai Icom Ltd.

No.101, Building 9, Caifuxingyuan Park,  
No.188 Maoting Road, Chedun Town,  
Songjiang District, Shanghai, 201611, China  
Phone: +86 (021) 6153 2768  
Fax: +86 (021) 5765 9987  
E-mail: [bjicom@bjicom.com](mailto:bjicom@bjicom.com)  
URL: <http://www.bjicom.com>

## RECEIVER

Receiver system	Direct Sampling Superheterodyne			
Intermediate frequency	12 kHz			
Sensitivity* <sup>4</sup>	0.5–1.799 MHz	1.8–29.999 MHz	28.0–29.7 MHz	50–54 MHz
	SSB/CW (at 10 dB S/N)	–	0.16 μV typ.	–
	AM (at 10 dB S/N)	6.3 μV typ.	2.0 μV typ.	–
	FM (at 12 dB SINAD)	–	–	0.5 μV typ.

\*<sup>4</sup> HF: Preamp 1 ON, 50 MHz; Preamp 2 ON, BW: SSB/CW=2.4 kHz, AM=6 kHz, FM=15 kHz

Squelch sensitivity (Threshold)	SSB: Less than 3.2 μV (Preamp ON)		
	FM: Less than 0.32 μV (Preamp ON)		
Selectivity (Filter shape: Sharp)	More than	Less than	
	SSB (BW: 2.4 kHz)	2.4 kHz/–6 dB	3.6 kHz/–60 dB
	CW (BW: 500 Hz)	500 Hz/–6 dB	700 Hz/–60 dB
	RTTY (BW: 500 Hz)	500 Hz/–6 dB	700 Hz/–60 dB
	AM (BW: 6 kHz)	6.0 kHz/–6 dB	15 kHz/–60 dB
	FM (BW: 15 kHz)	12.0 kHz/–6 dB	20 kHz/–60 dB
Spurious and HF bands image rejection	More than 70 dB		
50 MHz band	More than 70 dB (Except for ADC Aliasing)		
Audio output power	More than 2.0 W (at 10% distortion with an 8 Ω load)		

## TUNER

Frequency range	1.9–50 MHz bands
Matching impedance range	16.7 Ω–150 Ω unbalanced (VSWR better than 3: 1)
Tuning accuracy	VSWR 1.5: 1 or less
Tuning time	2–3 seconds (average) (Maximum 15 seconds)

All stated specifications are subject to change without notice or obligation.

Supplied accessories: (May differ depending on version)

- Hand microphone, HM-219
- DC power cable
- Fuses
- Plugs